

# DSP POWER AMPLIFIER

## USER MANUAL

M-DSPA.402



# MACROM

# Contents

---

- Warranty ..... 3
- Safety information ..... 3
- Information on disposal of unit..... 3
- Features ..... 4
- Specifications ..... 4
- Product overview ..... 5
  - Front panel ..... 5
  - Speaker connectro pins layout ..... 5
- How to install and connect the APP ..... 6
  - APP installation ..... 6
  - APP overview ..... 6
- APP overview ..... 7
  - Main ..... 8
  - Equalizer ..... 9
  - Crossover filter..... 10
  - Setting channels..... 11
  - Time alignment ..... 12
  - Selector gain level..... 13
  - Selector frequency cuts ..... 13
  - Slope selector..... 13
- Connections ..... 14
  - Plug & Play ..... 14
  - Universal..... 14
  - System extension ..... 15
  
- Declaration of Conformity..... 16

## Warranty

---

Thank you for purchasing this Macrom product. Should your product need warranty service, please return it to the shop where you buy it or to the Macrom distributor in your country. The warranty does not cover damage due to improper use and or installation, incorrect connections to power supply and audio sources, exposure to excessive humidity, unauthorized repair attempts or modifications.

## Safety information

---

Before beginning with installation, disconnect the wire from the battery ground terminal to prevent any short during installation.

This subwoofer must properly installed by Macrom authorized installer. Improper installation may damage the unit and /or the vehicle. Verify all electrical and drivability of the vehicle before the installation.

## Information on disposal of unit

---



This product bears the selective sorting symbol for waste electrical and electronic equipment (WEEE).

This means that this product must be handled to the local collecting points or given back to retailer when you buy a new product, in a ratio of one to one (or one to zero if the external dimension is less than 25 cm) pursuant to European Directive 2012/19/EC in order to be recycled or dismantled to minimize its impact on the environment.

For further information, please contact your local or regional authorities.

Electronic products not included in the selective sorting process are potentially dangerous for the environment and human health due to the presence of hazardous substances.

The unlawful disposal of the product carries a fine according to the legislation currently in force.

## Features

---

4-channel amplifier with audio processor controlled by App for smartphones and Bluetooth streaming audio.

- 4-channel amplifier with DSP processor
- Hi-Resolution Audio streaming Bluetooth
- 4 high level inputs
- 4 amplified outputs
- 4 + 1 low level outputs (RCA)
- Bluetooth connection for regulation and control
- App dedicated for Android and iOS
- Active crossover By-pass, Low-pass, Hi-pass and Band-pass
- Time delay adjustable between 0 and 210 cm
- 31-band parametric equalizer
- Dynamic Bass adjustment
- Selector for switch-on mode (REMOTE or SIGNAL)

## Specifications

---

- Nominal output power 150 Watts x 4 channels (76W RMS).
- Frequency response from 20Hz to 20KH
- Noise signal ratio > 120dB
- Dynamic range > 100dB
- HD: 1KHz < 0.001%
- Bluetooth 2402MHz - 2480MHz operating frequency
- EIRP 1.40dBm power
- Standby current < 0.01mA
- Maximum current consumption 20A
- Operating voltage from 9Volt to 15.5Volt ===
- Dimensions: 195mm 130mm 38mm

# Product overview

## Front Panel

Notice: The graphic in this manual is for reference only, and may be different from the actual unit.

1. Remote control input (Optional)
2. Bluetooth antenna
3. Negative Terminal (GND)
4. Positive Terminal (+ 12BATT)
5. Fuse [20A]

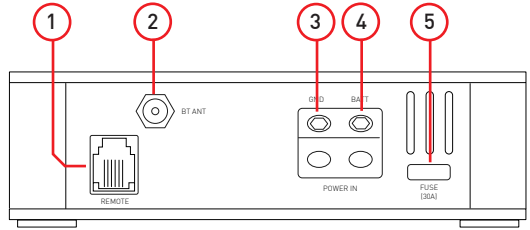

6. Update
7. Coaxial USB input
8. Subwoofer output
9. Rear REAR output
10. FRONT Front output
11. Power / Speakers Connector
12. 2/4 Ohm impedance selector
13. Optical input
14. Status Indicator (Power / Protection)
15. Power selector (High level signal / Remote in + 12V)

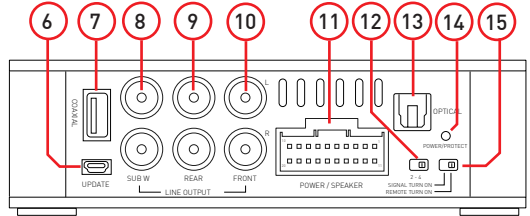

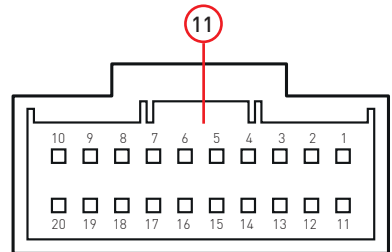

## Speaker connector pins layout

1. Front/Right + input
2. Front/Right - input
3. Front/Left + input
4. Front/Left - input
5. Rear/Left + input
6. Rear/Left - input
7. Rear/Right + input
8. Rear/Right - input
9. Remote output (+12V/Max 500mA)
10. Acc input
11. Rear/Right - output
12. Rear/Right + output
13. Rear/Left - output
14. Rear/Left + output
15. Front/Right - output
16. Front/Right + output
17. Front/Left - output
18. Front/Left + output
19. + Batt (12volts)
20. GND (Ground)



# How to install and connect the APP

## APP installation

1. Download the APP from Google Play or Apple Store searching for "M-DSPA.402" 
2. Install the application in your Android or iPhone mobile phone.
3. Activate Bluetooth on your mobile phone and search for "M-DSPA.402", then pair it.  
If necessary, the coupling code is 1234.
4. Open the "M-DSPA.402" APP and click on [  ], the amplifier will be connected and you can set your own sound from the available functions of the APP.
5. After completing the audio settings, click (Exit) to exit the APP.

## Bluetooth connection for Audio streaming

After pairing and connecting the M-DSPA.402 to your mobile phone you can associate the BT\_Audio device for playback Audio Streaming.

1. Access the Bluetooth settings of your mobile phone.
2. Associate the device "BT\_Audio\_M-DSPA.402"

Now you can play the music files from your mobile phone through the applications available on your device.  
By activating playback, the Macrom DSPA.402 will play your music.

In case of an incoming call, the Macrom DSPA.402 will transfer the audio to the your mobile phone.

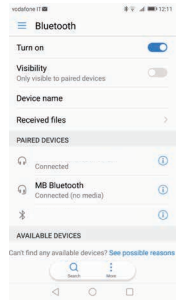

# How to install and connect the APP

## APP Installation

1. Download the APP from Google Play or Apple Store searching for "M-DSPA.402"
2. Install the application in your Android or iPhone mobile phone.
3. Activate Bluetooth on your mobile phone and search for "M-DSPA.402", then pair it.  
If necessary, the coupling code is 1234.
4. Open the "M-DSPA.402" APP and click on [ **Connect** ], the amplifier will be connected and you can set your own sound from the available functions of the APP.
5. After completing the audio settings, click (Exit) to exit the APP.

## APP overview

### Home

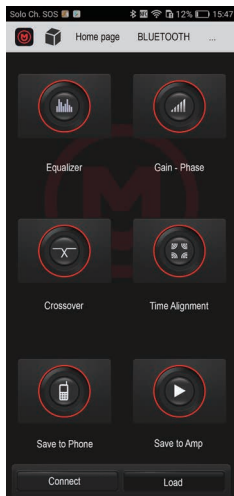

### Setting channels

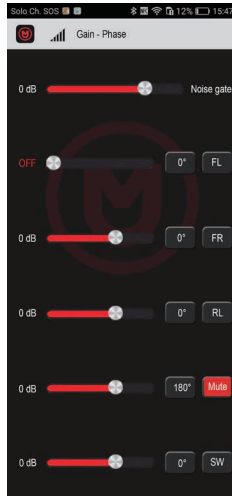

### Crossover Filter

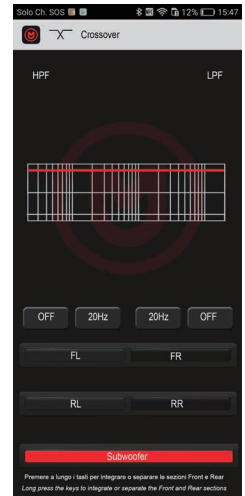

### Time alignment

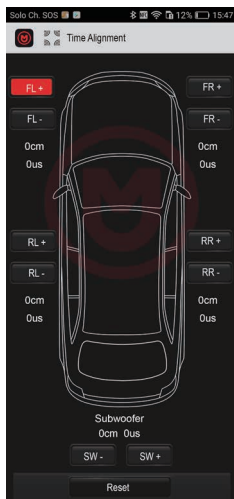

### Front & Rear equalizer

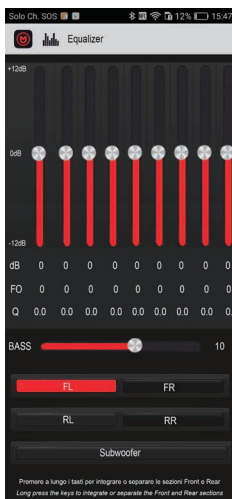

### Subwoofer equalizer

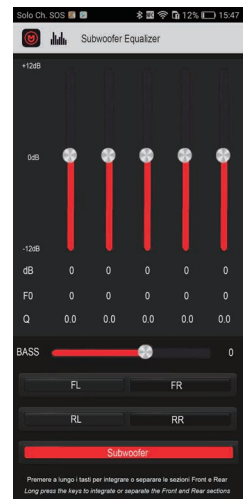

# APP overview

## Main

1. Parametric equalizer; click to get the equalization functions.
2. Crossover; click to get the crossover functions.
3. Save to phone; after finishing the setting, you can create the name of the audio setting and then with the (OK) button the audio setting will be saved in your mobile phone.
4. Connect; click to connect the amplifier from the APP.
5. Preselection of favorites; it is possible to recall the 5 presets saved in the amplifier.
6. Gain / Phase; click to get the functions of the levels.
7. Time alignment; click to get the alignment functions.
8. Save to amplifier; after finishing the setting, you can save your own audio setting in the five presets.
9. Load preset; click to load the presets stored on the mobile device.

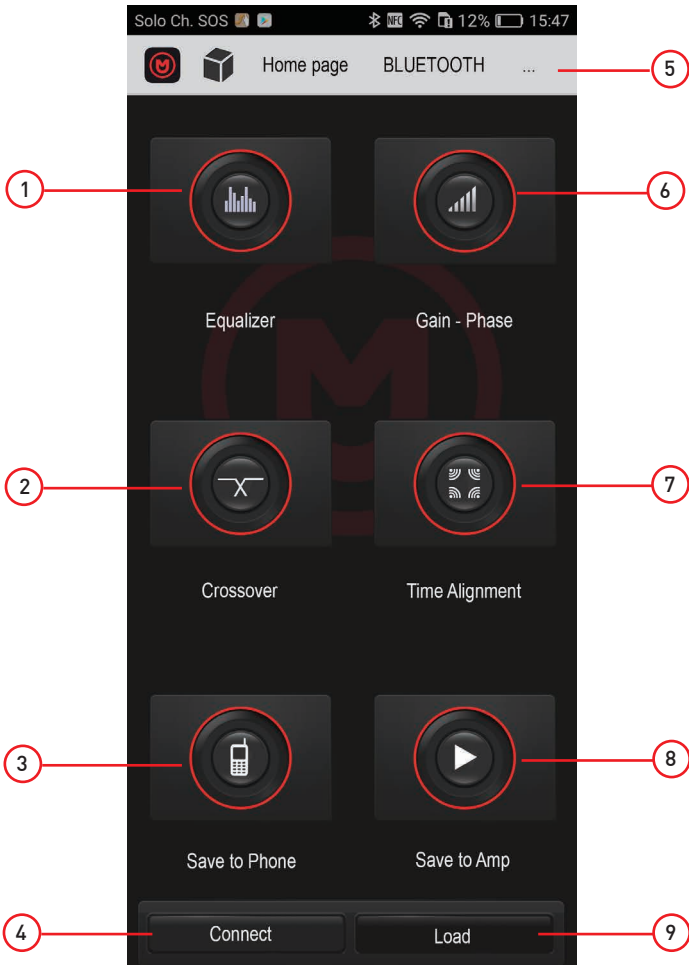



# APP overview

## Equalizer

1. 31-band equalizer adjustable from + 12dB to -12dB.
2. Gain indicator in dB
3. Dynamic bass selector
4. Front Left, front left section equalizer setting.
5. Rear Left, front left section equalizer setting.
6. Subwoofer, subwoofer section equalizer setting.
7. Variable frequency setting from 20Hz to 20.000Hz.
8. Q factor variable from 0.3 to 9.9.
9. Front Right, front right section equalizer setting
10. Rear Right, rear right section equalizer setting

Note:

long press the FL and / or FR, RL and / or RR keys for integration or separate sections Front and Rear.

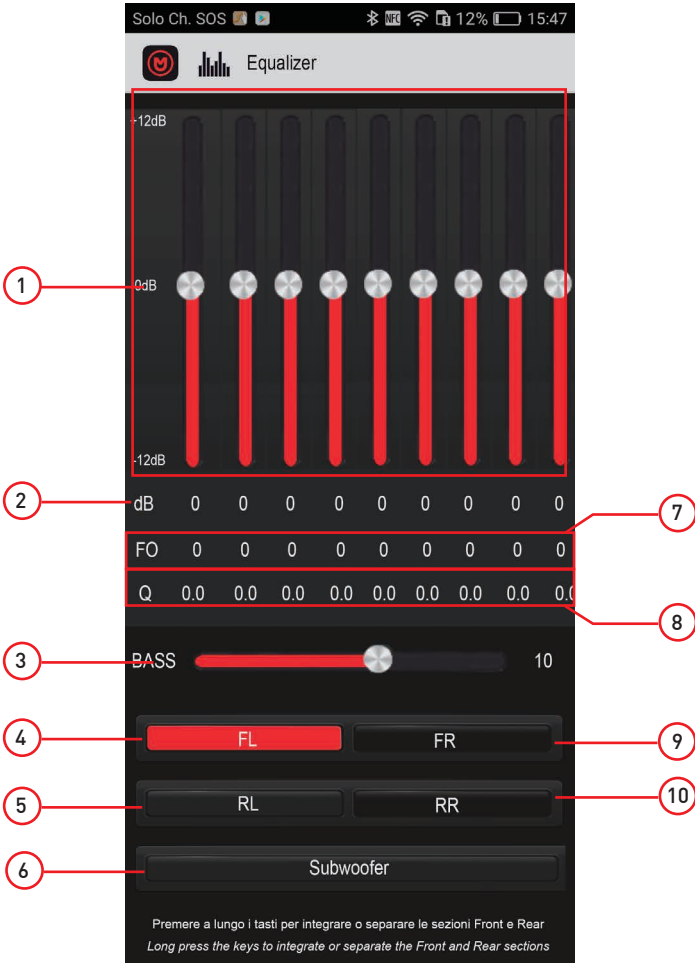

## APP overview

### Crossover filter

1. Overview of the graph.
2. Low cross-section frequency setting, adjustable from 20Hz to 20,000Hz.
3. Low-pass slope selector, selectable between, 6-12-18-24dB/oct or Bypass (Off).
4. Crossover selector section FL (front left).
5. Crossover selector section RL (rear left).
6. SUB crossover selector (subwoofer).
7. Setting high-pass frequencies, adjustable from 20Hz to 20,000Hz.
8. High pass slope selector, selectable between, 6-12-18-24dB/oct or Bypass (Off).
9. Crossover selector section FR (front right).
10. Crossover selector section RR (rear right).

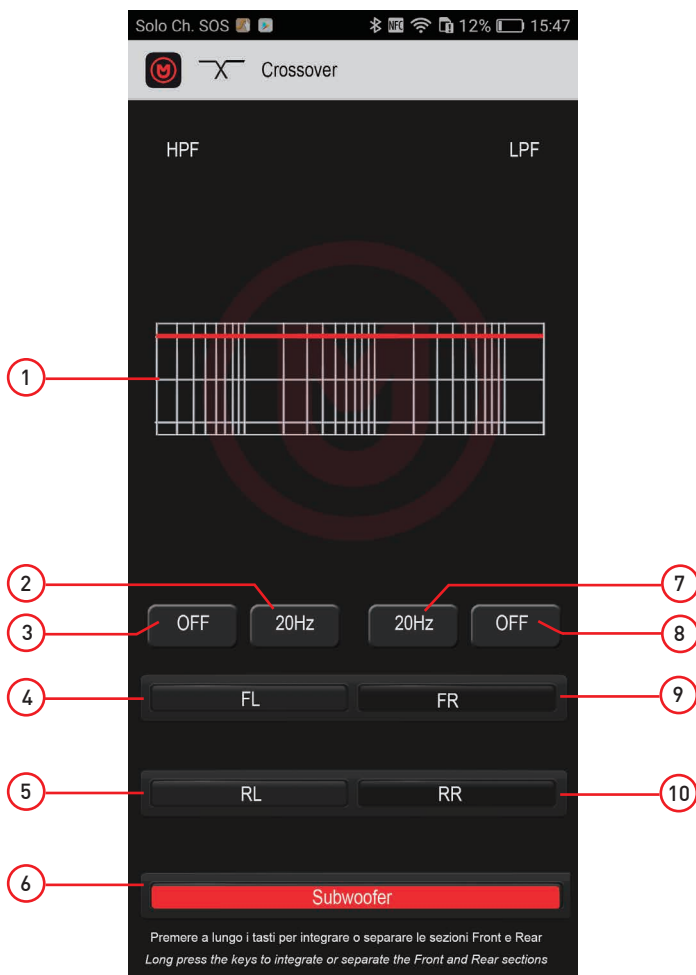

# APP overview

## Setting channels

- 1. Noise Gate, (noise cancellation)
- 2. FL - Front left gain slider, adjustable from Off to 0dB.
- 3. FR - Front right gain slider, adjustable from Off to 0dB.
- 4. RL - Rear left gain slider, adjustable from Off to 0dB.
- 5. RR - Rear right gain slider, adjustable from Off to 0dB.
- 6. SW - Subwoofer gain slider, adjustable from Off to 0dB.
- 7-8. FL - Front Left Phase Selector, 0 ° / 180 °, Front Left Mute, On / Off
- 9-10. FR - Front Right Phase Selector, 0 ° / 180 °, Front Right Mute, On / Off
- 11-12. RL - Rear Left Phase Selector, 0 ° / 180 °, Rear Left Mute, On / Off
- 13-14. RR - Rear right phase selector, 0 ° / 180 °, Rear right mute, On / Off
- 15-16. SUB - Subwoofer phase selector, 0 ° / 180 °, Subwoofer mute, On / Off

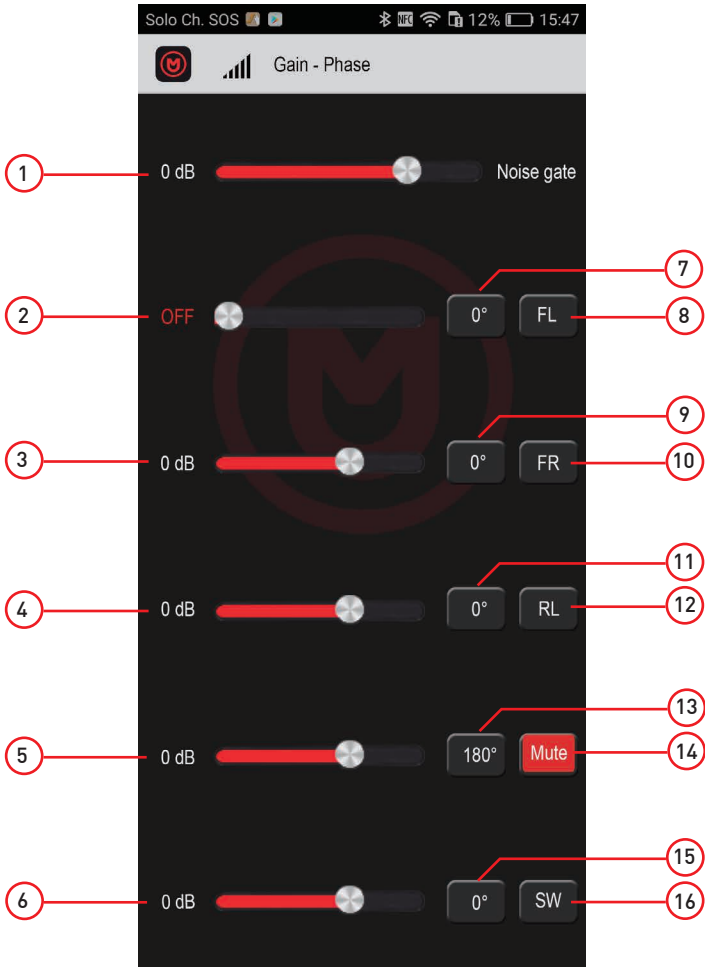

# APP overview

## Time alignment

1. FL (+) increase front right speaker delay.
2. FL (-) decrease front right speaker delay.
3. RL (+) increase of rear right speaker delay.
4. RL (-) decrease delay speaker rear right.
5. SUB (-) subwoofer delay decrease.
6. Parameter reset
7. FR (+) increase front right speaker delay.
8. FR (-) decrease front right speaker delay.
9. RR (+) increase of rear right speaker delay.
10. RR (-) decrease delay speaker posterior right.
11. SUB (+) subwoofer delay increase.

The time delay is adjustable between 0 and 210cm

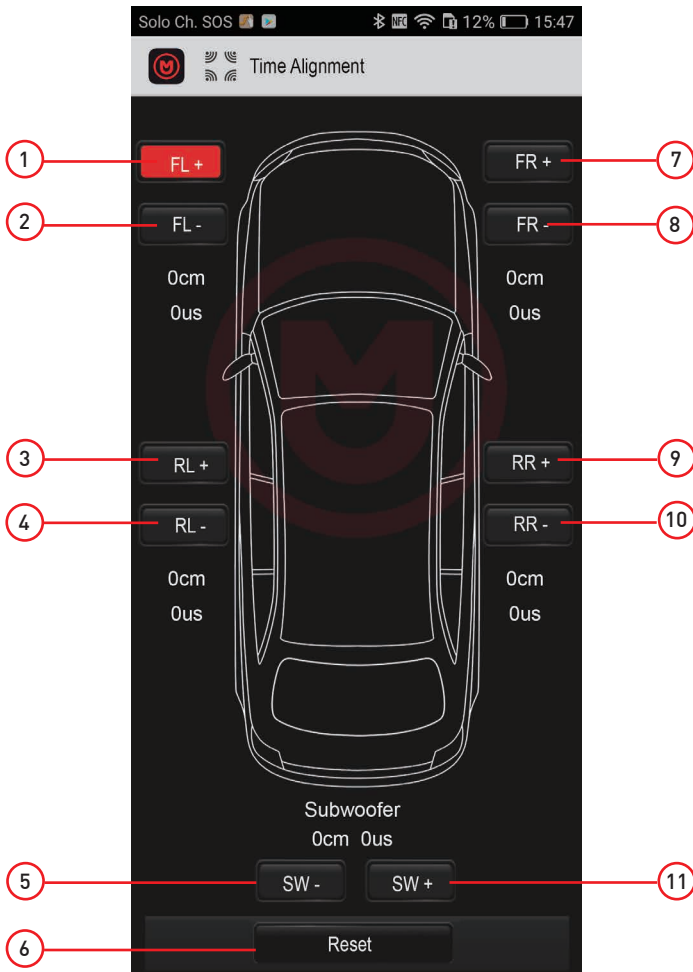

## APP overview

---

### Selector gain level

1. Value of the chosen level between Off and 0dB (max).
2. Cursor to change the value of the level.



### Selector frequency cuts

1. Cancel, selection cancel
2. Type the value of the selected cutoff frequency between 20Hz to 20,000Hz.
3. OK, press to confirm the selection.

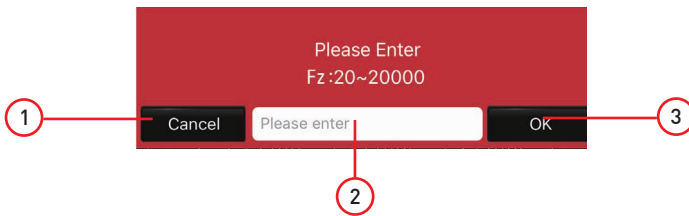

### Slope selector

1. Slider selection cursor  
The selection varies between:
  - Bypass
  - 6dB/octava
  - 12dB/octava
  - 18dB/octava
  - 24dB/octava

NOTE: no cutting or gradient applied to the selected section.

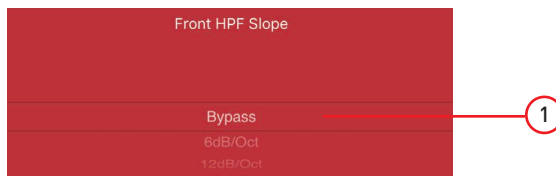

# Connections

## Plug & Play

### 1. Plug & Play wiring.

Interpose the Plug & Play wiring between the Car Stereo and the connector coming from the car and connect the end to the M-DSPA.402 amplifier.

*Note: Consult the list of cables available at [www.macrom.it](http://www.macrom.it).*

### 2. OPTIONAL: For greater power and sound quality, it is possible to upgrade the power supply as shown in the diagram.

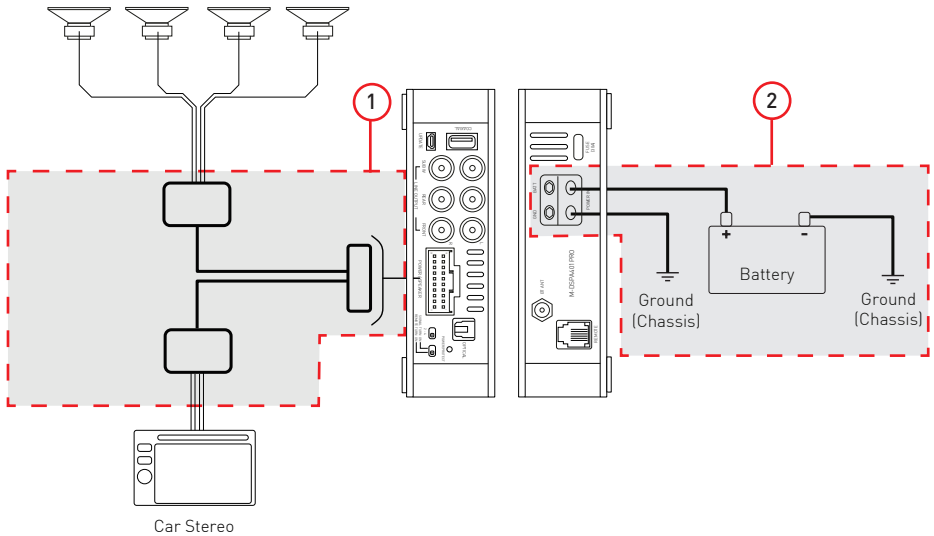

## Universal

### 1. Universal wiring

Follow the instructions on page 5 paragraph 6.

### 2. Power terminal

See the Plug & Play paragraph description.

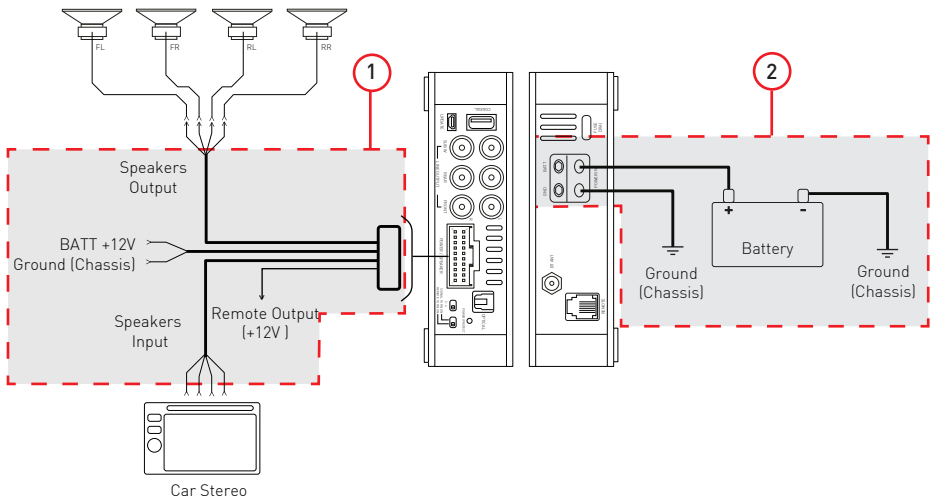

# Connections

## 1. System extension

Thanks to the pre-amplified outputs on the product it is possible to expand the system by adding an amplified subwoofer.

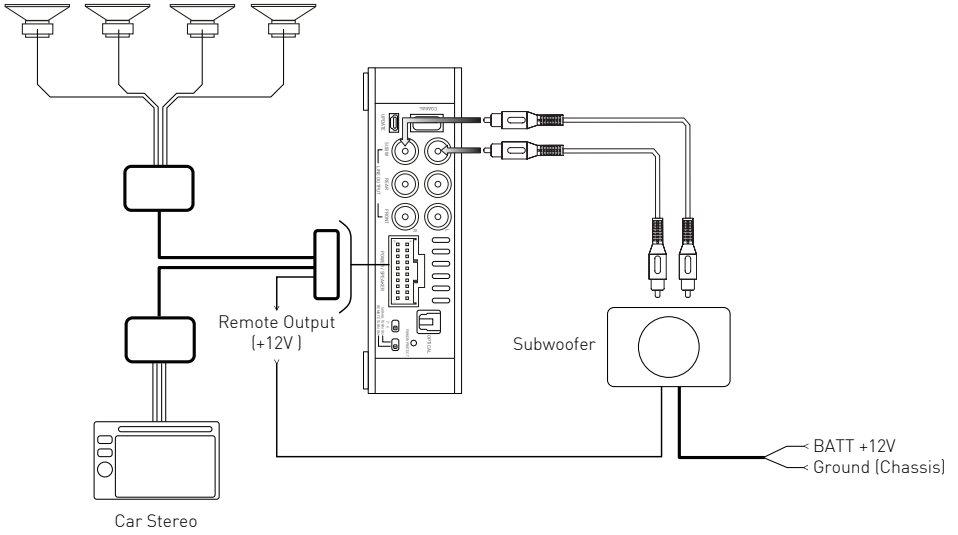

## 2. System extension

Thanks to the pre-amplified outputs on the product, it is possible to expand the system by adding a multi-channel amplifier (4 + 1) to enhance the audio system.

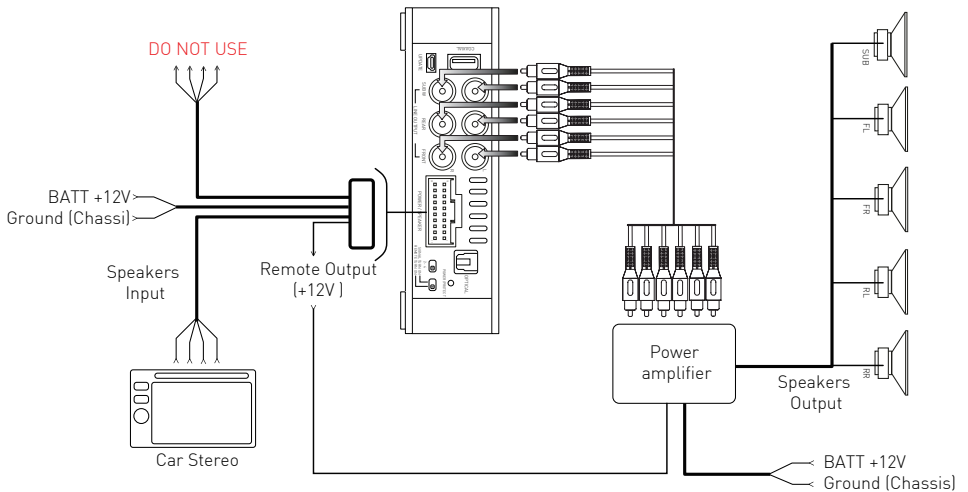

# Declaration of Conformity



M-DSPA.402 DSP POWER AMPLIFIER

Hereby G.M.A. ITALIA s.r.l. declares that this model M-DSPA.402, Macrom brand is in compliance with the essential requirements and other relevant provisions established by the R&TTE Directive 1999/5 / EC.

The full text of the EU Declaration of Conformity is available at the following Internet address:

[www.macrom.it](http://www.macrom.it),

or at

G.M.A. ITALIA s.r.l., Via G. Di Vittorio 7/33 - 20017 Rho (MI) Italy

Made in China by

G.M.A. ITALIA s.r.l.

Via G. Di Vittorio 7/33 - 20017 Rho (MI) Italy





**G.M.A. ITALIA s.r.l.**

Via G. Di Vittorio 7/33 - 20017 Rho (MI) Italy

w w w . m a c r o m . i t