

RADIO RECEIVER

USER MANUAL M-DL3300DAB



DAB+
Digital Audio Broadcasting

MACROM

Safety Precautions

Thank you for purchasing this product. Please read through these operating instructions so you will know how to operate your model properly. After you've finished reading the instructions, keep this manual in a safe place for future reference.

Only connect the unit to a 12-volt power supply with negative grounding.

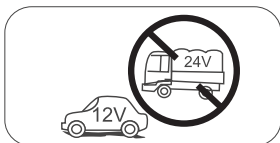

Never install this unit where the operation & condition for safe driving is impaired.

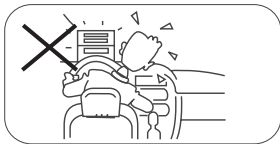

Never expose this unit, amplifier, and speakers to moisture or water to prevent electric sparks or fire.

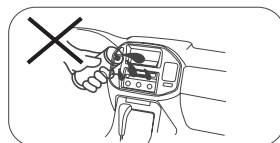

To ensure safe driving, please adjust the volume to a safe and comfortable level in case of emergency situations.

Please don't change the fuse on the power cord without professional guidance, using improper fuse may cause damage to this unit or even cause fire.

Safety Precautions

1. Never disassemble or adjust the unit without any professional guidance.
For details, please consult any professional car shop / dealer for inquiry.
2. If the front panel or TFT monitor is dirty, please use a clean silicone cloth and neutral detergent to wipe off the spot. Using a rough cloth and non-neutral detergent such as alcohol for cleaning may result in scratching or decoloration to the monitor.
3. If any abnormal behavior of the unit is found, please refer to trouble shooting guide of this manual. If no relevant information is found, please press the [RESET] key on the front panel to resume factory default.
4. If you have parked the car in hot or cold weather for a long time, please wait until the temperature in the car becomes normal before operating the unit.
5. Using the car heater in low temperature environment may result in moisture inside the unit, DO NOT use the unit in this situation. Eject the disc and wipe off the moisture on the disc. If the unit still doesn't work after a few hours, please contact the service center.
6. Do not impact the LCD monitor which could cause damage.
7. To prevent damage to the screen, avoid touching it with sharp objects.
8. To provide a clear demonstration and an alternative for easy understanding to the operation of this unit, graphic illustrations are used.
However, some illustrations are different from the actual images displayed on the screen.
9. Operate the unit correctly according to this manual to prevent unnecessary problem. The guarantee won't be valid if the problem is caused by inappropriate operation.

Installation

- Before final installation, connect the wiring temporarily and make sure it is all working properly.
- Use only the parts included with the unit to ensure proper installation. The use of unauthorized parts can cause malfunctions.
- This item must be installed by an authorized dealer in order to keep the warranty valid.
- Install the unit where it does not get in the driver's way and cannot injure the passenger if there is a sudden stop, like an emergency stop.
- Avoid installing the unit where it would be subject to high temperature, such as direct sunlight, or hot air, heater or where it would be subject to dust dirt or excessive vibration.
- Be sure to remove the front panel before installing the unit.

DIN Mount

Installation the unit

After inserting the half sleeve into the dashboard, select the appropriate tab according to the thickness of the dashboard material and bend them inwards to secure the holder in place.

1. Dashboard
2. Holder

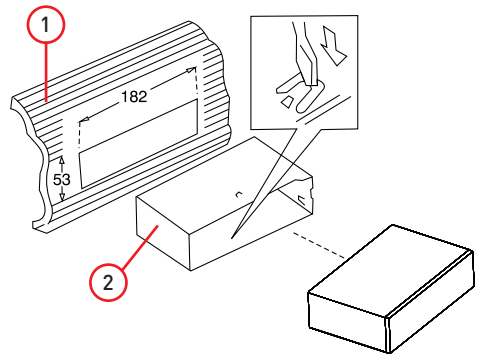

Removing the unit

- a. Frame
- b. Insert fingers into the groove in the front of frame and pull out to remove the frame.
(When re-attaching the frame, point the side with a groove down wards and attach it.)
- c. Insert the levers supplied with the unit into the grooves at both sides of the unit as shown in figure until they click. Pulling the levers makes it possible to remove the unit from the dashboard.

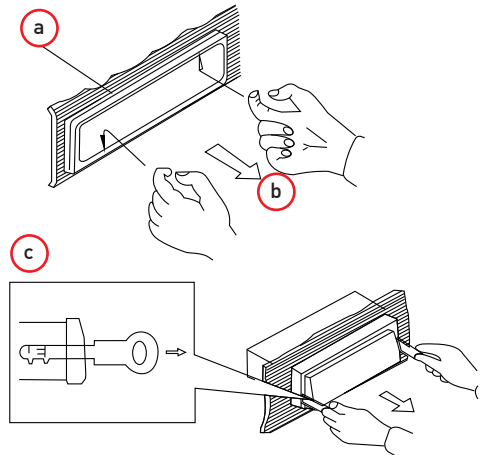

Installation

Detachable control panel (D.C.P.)

Removing the detachable control panel

1. Turn the power off
2. Press the D.C.P release button
3. Remove the D.C.P

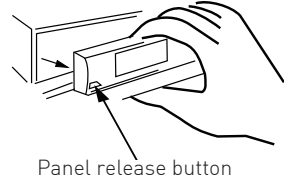

Attaching the detachable control panel

1. Insert the panel from the right side.
2. Then press the left side of D.C.R to hook up properly to the radio unit

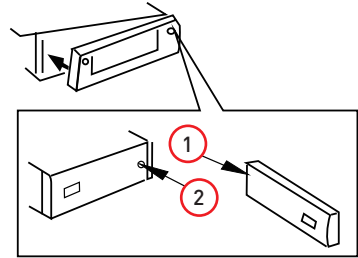

CAUTION

- DO NOT insert the D.C.P from the left side. Doing so may damage it.
- The D.C.P can easily be damaged by shocks. After removing it, place it in a protective case and be careful not to drop it or subject it to strong shocks.
- When the release button is pressed and the D.C.P is unlocked, the car's vibrations may cause it to fall.
- The rear connector that connects the main unit and the D.C.P is an extremely important part. Be careful not to damage it by pressing on it with fingernails, pens, screwdrivers, etc.

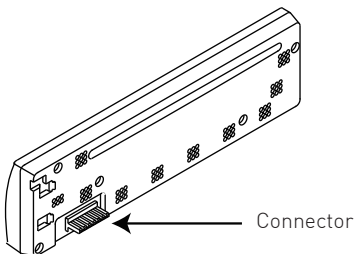

Note:

If the D.C.P is dirty, wipe off the dirt with soft, dry cloth only. And use a cotton swab soaked in isopropyl alcohol to clean the socket on the back of the D.C.P.

Product overview

Front Panel

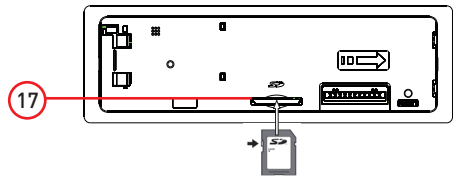
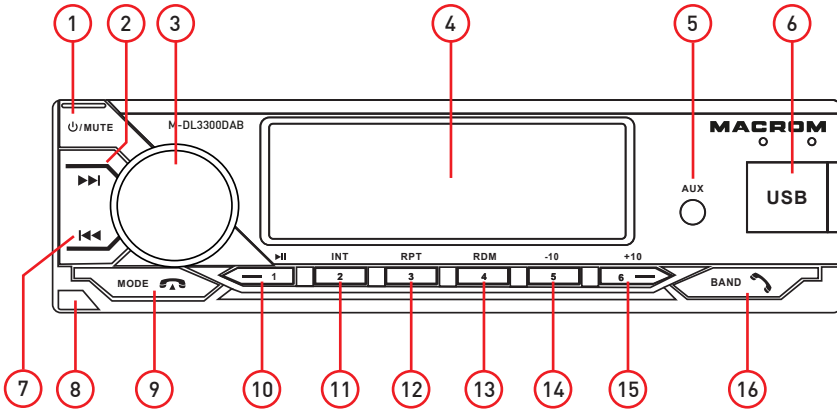

Warning:

The images in this manual are indicative only and may differ from the actual product. Refer to the actual device unit.

1. Power button (On / Off) and Mute
2. Search for next track / next radio station
3. Volume control and settings selection (Menu)
4. Display
5. Auxiliary 3.5mm Jack audio input
6. USB port
7. Search previous track / previous radio station
8. Release button
9. Switch button (AM/FM-DAB-Bluetooth-USB-SD-Aux IN) Bluetooth call endgup
10. Preset 1 / Play-Pause
11. Preset 2 / Track introduction
12. Preset 3 / RPT repeat
13. Preset 4 / RDM random play
14. Preset 5 / 10 second back / SD / USB lists and menus
15. Preset 6 / 10 second advance / SD / USB lists and menus
16. BAND / Bluetooth call answer selector
17. SD / MMC socket

General Operations

Power On/Off button and MUTE button

Press to turn on the unit, press and hold the button to turn off the unit.

Press quickly to mute the unit (Mute)

Menu key

Press the MENU key to navigate through the menu items as follows:

AUTO (BLUE / GREEN / CYAN / RED / PURPLE / YELLOW / WHITE) --> VOLUME (VOL) --> BASSI (BAS) --> ALTI (TRE) --> BALANCE (BAL) --> FADER (FAD) --> LOUD--> EQ (POP / ROCK / CLASSIC) --> DX --> STEREO

Rotate the volume control to adjust the desired level within 3 seconds.

In radio mode, press and hold the Menu key to access the following settings:

AF (ON / OFF)--> TA (ON / OFF)--> PTY (SPEECH / MUSIC)

LOC / DX mode

Use this mode to change the local (LOC) and distant (DX) tuning sensitivity.

Local mode improves reception in some areas where the signal is too strong.

EQ (Preset Equalizer) Button

OFF --> POP --> ROCK --> CLASSIC

With the DSP equalizer turned off, the tone level will be controlled with the Bass / Treble setting.

LOUD button

This LOUDNESS control allows you to increase the level of the bass.

Telephone answer key

Press this key to answer / accept the call.

During the conversation, press and hold to transfer the call.

Phone close button

Press this key to reject or end the call.

MODE key

Press this button to select different sources, in sequence as follows:

- 1) Radio mode AM/FM
- 2) Radio mode DAB
- 3) Audio AUX-IN
- 4) BT Audio Bluetooth
- 5) USB playback
- 6) SD playback

RESET button

The RESET button is located on the front panel (as shown in the image 1).

Pressing vertically with a ballpoint pen or metal object will activate it.

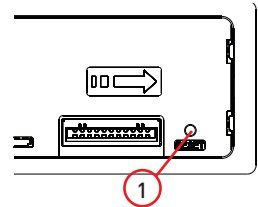

Note:

If the drive does not operate normally after the reset, use a cotton swab dipped in isopropyl alcohol to clean the socket on the back of the control panel.

General Operations

RADIO

1. Band selection:
press BAND to select the FM / AM band: FM1, FM2, FM3 / AM1, AM2
2. Search for radio stations: In radio mode, press or to search for radio stations.
If a radio station is found, it will automatically stop and start playing.
3. 6 radio stations can be pre-stored in each band. A total of 32 radio stations (18 FM, 12 AM) can be pre-stored in this unit.
4. Manually pre-store the radio station:
press and hold the desired preset button from (1-6) for about 3 seconds to save the frequency of the received radio station. Repeat for all 6 presets for each band.

Up / Down tuning key (◀◀ / ▶▶)

Press this button to search for radio stations.

Preset buttons (M1-M6)

Six preset radio stations can be stored and recalled by pressing the M1-M6 buttons

TO STORE A STATION:

- 1) Select a band (if necessary)
 - 2) Select a station by tuning with the ◀◀ / ▶▶ buttons.
 - 3) Press and hold a preset button for at least 2 seconds to store the station.
- The display will show the preset number accompanied by a beep.

TO RECALL A STATION:

- 1) Select a band (if necessary)
- 2) Briefly press a preset button to recall the stored station.

Auxiliary input

Connect the external device to the front 3.5mm jack, then press the Mode button to select the AUDIO IN mode. Press the Mode button again to return to the previous mode.

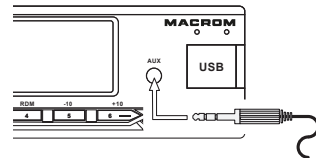

USB/SD device

Connect the USB / SD drive, switch to USB / SD by pressing the MODE button. USB / SD will appear on the display to indicate that the device is connected correctly and playback has started.

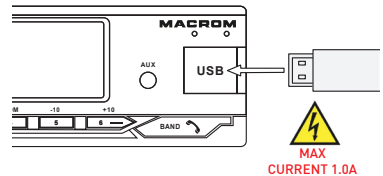

It is possible to recharge the smartphone via the USB socket having a maximum current of 1A.

STOP PLAYBACK

1. By disconnecting the USB / SD device, the unit stops playback.
Or use the MODE key to switch to another mode.
2. Use the MODE key to choose USB / SD mode again
(The function is only active if the USB / SD device is connected to the unit).

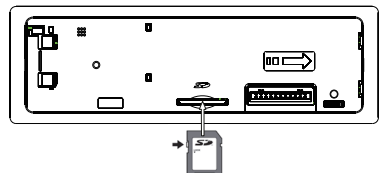

MP3/SD/USB Operations

Play/Pause button Track

Short press **P1** button to pause MP3 playback, press again to release pause.

Intro/Scan button

Press the **P2** button to select the Intro Scan function, the first 10 seconds of each song will be played sequentially until this button is pressed again, then normal playback will resume at the current track.

Repeat button

Pressing the **P3** key will activate the Repeat function in the following order:
RPT ONE → RPT DIR → RPT ALL

Random button

When the random play mode is selected, the tracks will be played in random order, press **P4** again to cancel the random play mode.

Next/Previous Track button

In normal playback mode, press **▶▶** the button for less than 1 second to skip to the next track or press the button **◀◀** to return to the beginning of the current track.
Press repeatedly to step through the previous or next tracks.

Keeping the **▶▶** or **◀◀** key pressed activates the fast forward or rewind functions of the tracks.

Track key -10/+ 10

Pressing the **-10** key goes back 10 tracks while pressing the **+10** key advances 10 tracks. By keeping the **-10 / +10** key pressed, you access the folder directo

BAND button

By pressing the **BAND** key it is possible to view the following contents:
TILTE → SONG → ARTIST → ALBUM → FOLDER

MMC/SD card & USB Operations

Caution

Carefully unplug the USB socket from the unit, excessive force may cause permanent and severe damage to the drive and USB device.

Compatibility

This unit may not be compatible with all USB devices.

In particular, USB devices requiring a driver or a power supply of more than 1A.

Specifications supported

- * Support MAX 32G USB flash memory
- * Support MAX 999 Songs
- * USB 1.1 device support
- * USB 2.0 device support (Transfer speed same as ver 1.1)
- * File manager: FAT12/FAT16/FAT32
- * MP3/WMA/APE/FLAC

Note:

This unit is not compatible with portable Hard-Disc.

Start the SD mode

1. The Micro SD Card slot is located behind the front panel.
2. Insert the Micro SD Card into the slot in the correct direction until a CLIC sound is heard.
3. Select the SD PLAY function by repeatedly pressing the MODE button.

To stop SD playback

1. The SD drive / device is unplugged, the unit will stop playback.
Or use the MODE button to switch to another mode.
2. User can use the mode button to choose SD mode (only if SD drive / device is inserted in the unit) or any other modes, when they are in any mode.

SD/MMC specifications

- * Support MAX 32G SD/MMC card
- * Support MAX 999 SONGS
- * File manager FAT12, FAT16, FAT32 Supported

Caution

Please make sure to insert the Micro SD card in the correct direction / orientation as indicated in picture. Wrong insert will cause permanent & serious damage to the unit & the Micro SD card.

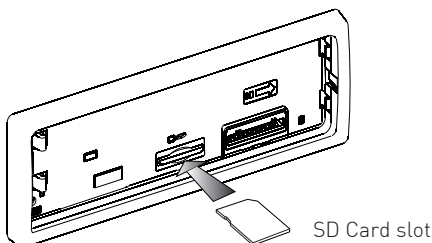



Bluetooth Mode

Connection



1. Select the BT audio source by pressing the MODE button repeatedly.
The display shows the message "CONNECT".
Activate the Bluetooth function on the mobile phone and select the Bluetooth device name "M-DL3300DAB"
2. Wait until the connection is complete, the unit display shows "BT ON" and the name of your device.
3. You should automatically connect, some devices may require a password. If prompted, the password is 0000.

Operation

1. The phone numbers of the incoming calls will be displayed on the LCD screen.
Press the button (**BAND** ) to receive the call and when the call is finished, press the button (**MODE** ) to hang up.

Note:

To make a call, you need to dial the number using your smartphone.
By pressing the (**BAND** ) key, the last number called is forwarded.

2. To activate the BT AUDIO "A2DP" (Streaming Audio) mode, activate the music function on your device and adjust the phone level to maximum output and press Play to start audio playback.
Using the key  it is possible to go to the next track or press the key  to go back to the previous track.

Note:

- * Some cellphones may not support BT function and Music Bluetooth (A2DP) mode.
- * To disconnect a device, select deactivate the BT function from the smartphone.

DAB Radio

Functions

1. Press the **MODE** button to switch to DAB mode.
When entering DAB mode for the first time, no signal is output but "LINK" is displayed.

Operation

SCAN:

Press and hold the **BAND** button for 3 seconds, the DAB will scan for radio stations available.

The display will show the number of stations received and the first station received will be replayed.

Press and hold the preset buttons for about 2 seconds to store the desired station in the positions of buttons 1/6.

Press briefly to recall the stored station.

Press  /  repeatedly until the desired channel / frequency is displayed.

Wire Connections

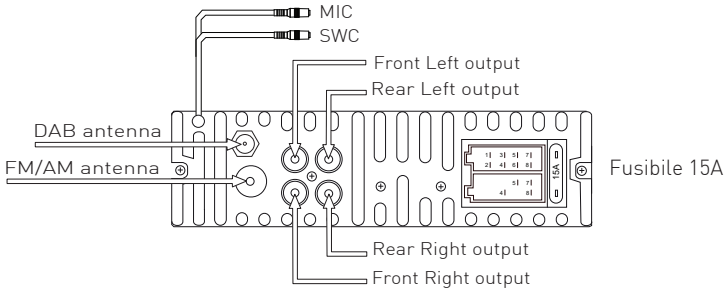

Connector A (Output speaker)

1. Rear Right (+)
2. Rear Right (-)
3. Front Right (+)
4. Front Right (-)
5. Front Left (+)
6. Front Left (-)
7. Rear Left (+)
8. Rear Left (-)

Connector A

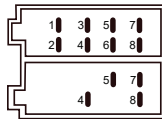

Connector B

Connector B (Power/service)

1. nc
2. nc
3. nc
4. Battery +12V
5. Antenna (+12V output)
6. nc
7. ACC (+12V ignition)
8. GND (ground)

Specifications

General

Power supply	12V
Operating voltage range	11 - 14.4V
Ground system	Car battery negative pole
Maximum current level	15A

Power

Frequency response	(± 3dB) 20Hz ~ 20KHz
Maximum output power	4 × 50W
Load impedance	4-8Ω

Line output

Audio output impedance	10KΩ
Audio Output Level	2000mVrms (Max)

FM Radio

Frequency range (EUR)	87.5 - 108.0 MHz
Sensitivity	Better than 10 dB at S/N 30 dB
Stereo separation	35 dB at 1KHz
Residual noise sensitivity S/N	50dB

AM Radio

Frequency range (EUR)	522 - 1620 KHz
Sensitivity	Better than 45 dB
Residual noise sensitivity S/N	40 dB

DAB Radio

Frequency range	174.928 - 239.200 MHz
Sensitivity	Better than 93 dB
Stereo separation	50 dB at 1KHz
Residual noise sensitivity S/N	65 dB

BT

Version	4.2
Frequency	2.402 - 2.480 GHz
EIRP power	3.3 dBm

Software Version

MCU	Ver 08020933
-----------	--------------

Declaration of Conformity



The manufacturer Aldinet S.p.A declares that the type of radio equipment- AM/FM/ radio receiver and USB/SD card reader, model M-DL3300DAB, brand Macrom - complies with the 2014/53 / EU Directive.

The full text of the EU Declaration of conformity is available at the following internet address: www.macrom.it, or at

G.M.A.Italia s.r.l via G. Di Vittorio 7/33 - 20017 - Rho (MI) Italia

Made in China by

G.M.A.Italia s.r.l via G. Di Vittorio 7/33 - 20017 - Rho (MI) Italia

Information on disposal of unit



This product bears the selective sorting symbol for waste electrical and electronic equipment (WEEE).

This means that this product must be handled to the local collecting points or given back to retailer when you buy a new product, in a ratio of one to one (or one to zero if the external dimension is less than 25 cm) pursuant to European Directive 2012/19/EC in order to be recycled or dismantled to minimize its impact on the environment.

For further information, please contact your local or regional authorities.

Electronic products not included in the selective sorting process are potentially dangerous for the environment and human health due to the presence of hazardous substances.

The unlawful disposal of the product carries a fine according to the legislation currently in force.

MACROM

w w w . m a c r o m . i t